

North Shore Squares



Beginning Square Dance

Club 50 Calls

Bruce Holmes & Jill Sullivan

Edited by Dave Mischler

copyright © 2015-2018 by Holmes & Sullivan, all rights reserved

TABLE OF CONTENTS

Getting Started	4-5
Class 1	6-9
Circle Left / Right	
Forward and Back	
Promenade / Promenade Half	
Arm Turns / Allemande Left	
Weave the Ring	
Right and Left Grand	
Stars	
Ladies Chain Across and $\frac{3}{4}$	
Courtesy Turn	
Pass Thru	
Wheel Around	
Grand Square	
Star Thru	
Class 2	10-12
Half Sashay	
Roll Away	
Ladies Center and Men Sashay	
U-Turn Back	
Promenades (Single, Half, Wrong Way)	
Square Thru	
Bend the Line	
Dosado	
Class 3	13-14
California Twirl	
Slide Thru	
Dive Thru	
Right and Left Thru	
Make Lines	
Class 4	15-17
Trades	
Partner Trade	
Lead Right / Left	
Veer Right / Left	
Couples Circulate	
Boys / Girls Circulate	
Centers / Ends Circulate	
Centers Trade	
Ends Trade	
Chain Down the Line	
Class 5	18
Swing	
Flutterwheel / Reverse Flutterwheel	
Sweep a Quarter	

Class 6	19-21
Wheel and Deal Double Pass Thru First Couple Left / Next Couple Right Circle to a Line	
Class 7	22-23
Ocean Waves and Rule Alamo Style Trade Right / Left Swing Thru / Left Swing Thru Step to a Wave Dosado to a Wave Run	
Class 8	24-25
Ferris Wheel Pass the Ocean Extend Circulates From an Ocean Wave / All 8 Circulate	
Class 9	26-27
Zoom Trade By Girls / Boys Trade in a Wave	
Class 10	28-30
Box the Gnat Cross Run Hinge: Singles / Couples / Partner Touch a Quarter Column Circulate	
Class 11	31-32
Split Circulate Box Circulate Centers In Cast Off $\frac{3}{4}$ Left Hand Calls	
Class 12	33-35
Fold Cross Fold Tag the Line Half Tag the Line	
Class 13	36
Turn Through Scoot Back Recycle	
Class 14	37-39
Star Promenade Backtrack Separate and/or Go Around 1, 2, 3 to a Line / Down the Middle Split Two and/or Go Around 1, 2, 3 to a Line / Down the Middle	
Formations	40-42

GETTING STARTED

Home Position:

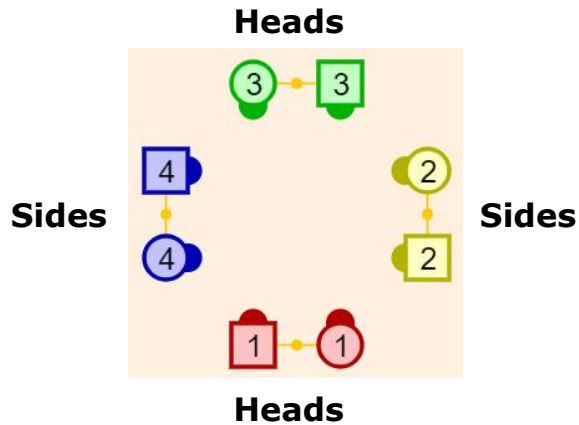

♪ Music and Caller ♪

Caller: The person directing the dancers with instructions known as calls.

Orientation: Everyone faces into the center of the square.

Home: Your starting position. You may be a head couple or a side couple within the square.

Heads: The couple facing the music and the couple with their backs to the music. They are couples 1 (back to the caller) and 3 (facing the caller).

Sides: The couples that are perpendicular to the music. They are couples 2 (to the right of couple 1) and 4 (to the left of couple 1).

Partner: Person beside you. Boy stands on the left, girl on the right. In diagrams, boys are shown as a square. Girls are shown as a circle. Your partner may change as the calls move you around.

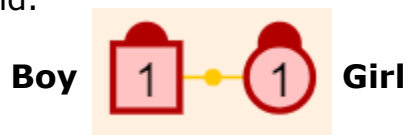

Corner: Person adjacent to you.
For boys, it is the girl to the left;
For girls, it is the boy to the right.

Hand Hold: Boy has right hand palm up, girl rests her left hand in his with palm down.

- Square Your Set:** Go back to your home position.
- Tip:** A round of dancing with the same square. There will usually be patter and a singing call.
- Patter:** Typically, there is music. The caller sends you through a series of calls, ideally putting you back with your partner at the end of each sequence.
- Singing Call:** A mix of caller directions and singing. There is a sequence of calls that repeats. There is a structure in which there is a chorus followed by 2 verses. During those verses, girls will be rotated to their corner and then to the boy opposite them at the beginning of the song. Following a second chorus, the next 2 verses will serve to advance the girl through the next 2 boys bringing her back home to her original partner.
- Thank You:** At the conclusion of each tip during a dance (and at the end of our class!), it is customary to thank everyone with whom you have been dancing. Beyond a group thank you, you connect individually with the people in your square with a handshake or friendly hug (also called a yellowrock).

CLASS 1

CALLS

Circle Left / Right: All dancers join hands and circle to the left or right.

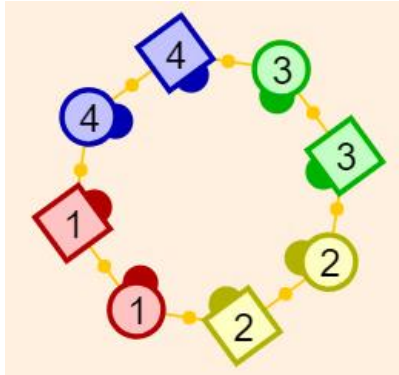

Forward and Back: Dancers step forward for 4 beats (1, 2, 3, touch) and then step back for 4 beats (1, 2, 3, touch).

Promenade: Walking counterclockwise to the right.
It may be done solo or in pairs.
Solo, you walk the inside of the square.
In pairs, you walk the outside of the square.
As pairs, connect right hand in right and left hand in left, with the joined right hands on top.

Promenade Half: Walking halfway around the square to the opposite side.
When designated couples are promenading (for example heads), the other two couples (sides) step into the center to give them more room. This is usually accompanied by quick hugs in the middle. Then quickly back up so that you're not in the way.

Arm Turns: May be done with right arms or left arms.
When done as a left hand turn with your corner, it is called an **Allemande Left**.

Weave the Ring: Boys face counterclockwise, girls face clockwise.
Everyone walks forward around the circle passing one another by alternating shoulders (right, left, right, left).

Right & Left Grand: Boys face counterclockwise, girls face clockwise. Travel is like Weave the Ring, but you pull by one another with alternating hands (right, left, right, left)

Stars: Connect hands in the center, right or left as designated, and walk once around. Right hand stars turn clockwise. Left hand stars turn counterclockwise.

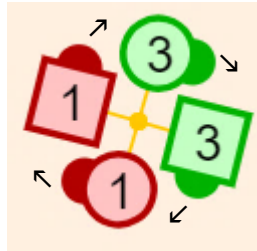

Right hand star

Ladies Chain: Girls (may be just two or all four) join right hands in the center and circle clockwise until they can offer their left hand to their target boy. They connect left hands and finish with a **Courtesy Turn**.

Across: Takes the girl to the boy opposite from her.

$\frac{3}{4}$: Takes the girl all the way around to her corner.

Courtesy Turn: With left hand in partner's left hand, the girl places her right hand behind her back. The boy places his right hand against her right hand. The girl walks forward as the boy backs up. Always finish facing into the center of the square.

Pass Thru: Pass right shoulders with the person opposite you and continue to face in direction of travel.

Start:

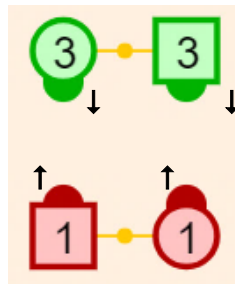

Finish:

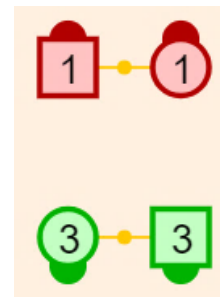

Wheel Around: While in the normal couple hand hold, the girl walks forward and the boy backs up. The pair turns 180° to face the opposite direction.

Start:

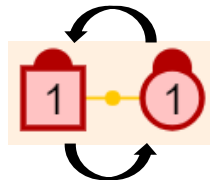

Finish:

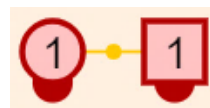

Grand Square:

Walking is done in a mini square in your corner of the larger square. You will always be facing your partner or the person opposite you. If you are near the person you are facing, walk backward. If you are some distance from the person you are facing, walk forward. The count is 1, 2, 3, pivot. Do not pivot at the halfway point, when you find yourself back at home. At that moment, reverse the process. Be sure to stay with the beat.

First Half for Female 4 (sides face):

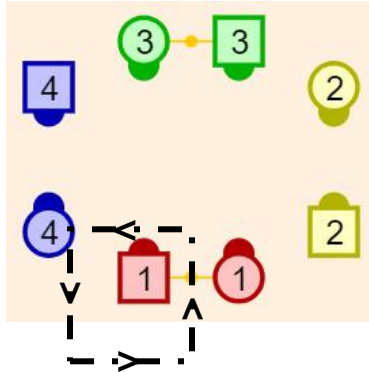

Second Half for Female 4 (sides face):

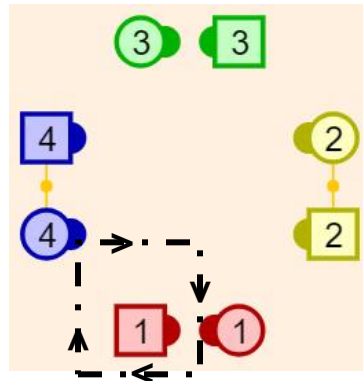

Star Thru:

With the person opposite, girls extend left hands and boys extend right. The hands raise as you pass right shoulders with each other and the girl steps under the joined hands. She turns 90° to her left and he faces 90° to his right to become new partners.

Start:

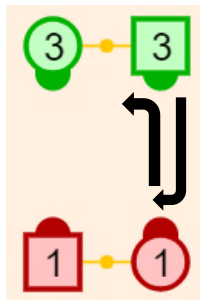

Finish:

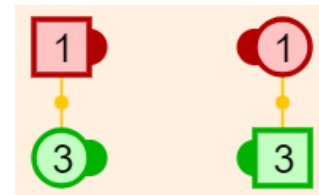

FORMATIONS

One Faced Line:

Lines Facing In

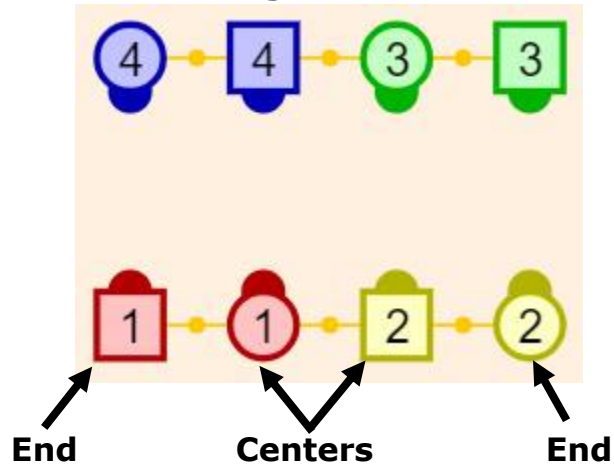

Lines Facing Out

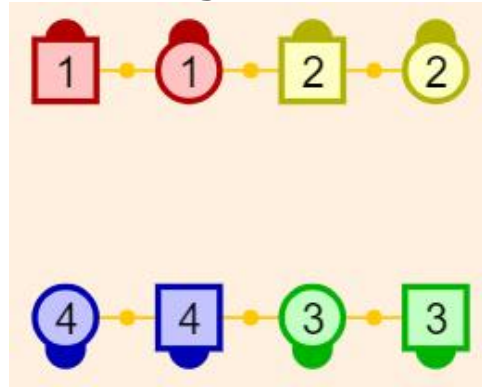

Two Faced Line:

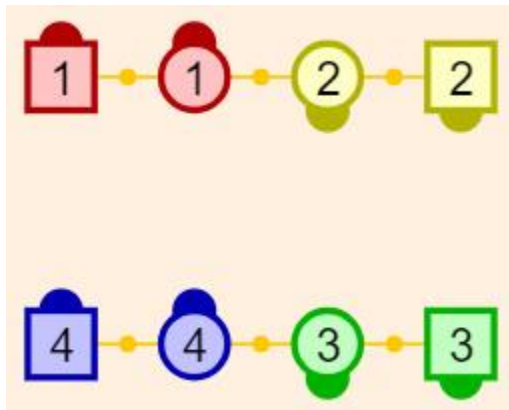

CLASS 2**CALLS****Half Sashay:**

Person on the right slides in front of the person on the left into their partner's position. Person on the left slides behind the person on the right into their partner's position. Slide means you do NOT change your facing direction. When used as an adjective, half sashayed means the couple is out of their standard position—the girl is on the left and the boy is on the right (see formation diagram)

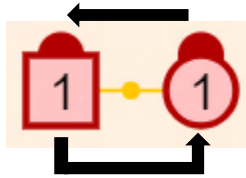
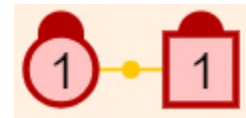
Start:**Finish:****Roll Away:**

Person on the right (usually the girl) rolls across in front of the person on the left as that person (usually the boy) slides to the right. They switch connected hands at the midpoint. It results in being half sashayed so the call is sometimes **Roll Away with a Half Sashay**. Remember that a little arm tension makes it easier (and more fun!)

**Ladies Center,
The Men Sashay:**

You are typically circling left when this is called. Everyone releases hands and ladies step into the middle, while the men keep moving around the circle. When the ladies step back out the boy on their right will now be the boy on their left, and everyone reconnects hands.

U-Turn Back:

Turning around 180° to face the opposite direction. If with a partner, turn toward your partner. If acting alone, turn toward the center of the square.

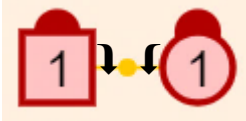
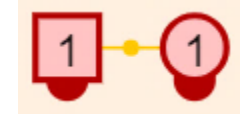
Start:**Finish:****Promenades:**

Walking around the square (couples) or inside the square (individuals). All are typically done counterclockwise or toward the right. Some may involve designated couples and only moving a fraction around the square. If it was Heads **Promenade Half**, the Side couples would move into the center of the square and huddle up to make room for the Heads to walk by to the opposite Head position. **Wrong Way Promenade** involves walking clockwise, instead of the typical counterclockwise.

Square Thru:

Done in a group of four people, you walk a square by passing another person and pivoting toward the center. On the last pass, you do not pivot but walk straight forward. You alternate hands beginning with the right (unless **Left Square Thru** is called). If no number is called, the default is 4 (3 pivots and 1 straight out). Square Thru 3, 2, and even 1 are possible.

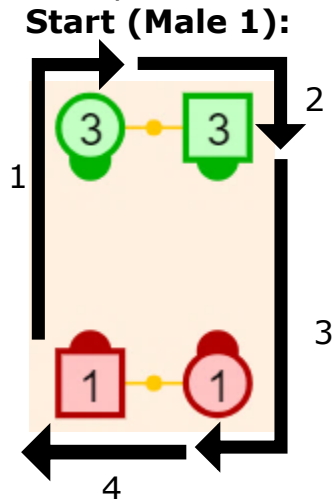

Finish:



Bend the Line:

The line divides in two and each half moves 90° to bend and face the center of the formation. To make this happen, the Centers back up and the Ends move forward.

Start:

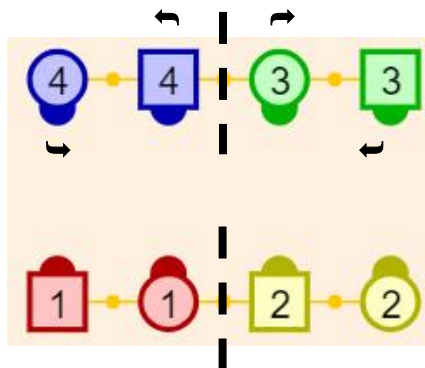

Finish:

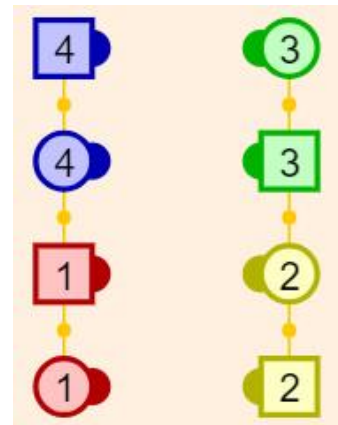

Dosado:

Pass right shoulders with the person you're facing and slide to your right passing back to back. Finally, back up, passing left shoulders. End where you started.

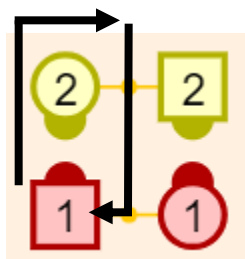

FORMATIONS
Facing Couples:
Normal

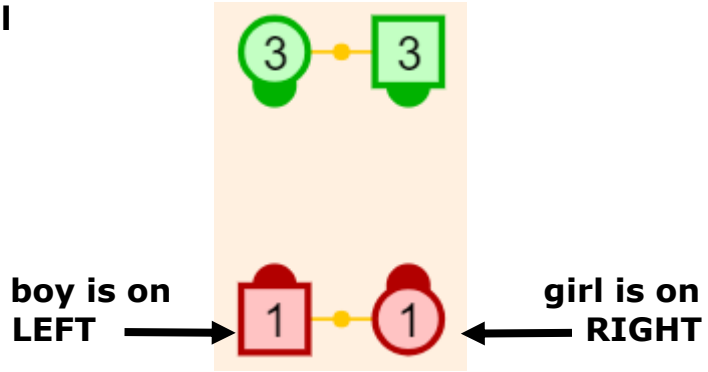

Half Sashayed

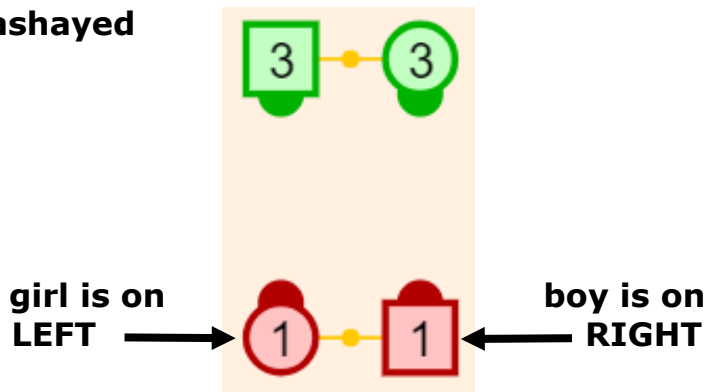

CLASS 3

CALLS

California Twirl:

It turns you and your partner to face in the opposite direction. You raise your joined hands and walk forward a 1/2 circle, passing right shoulders. The girl steps under the joined hands while she turns toward her left shoulder. The boy turns toward his right.

Start:

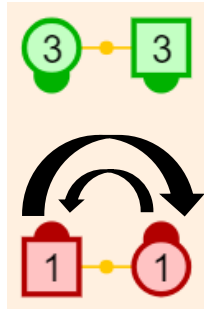

Finish:

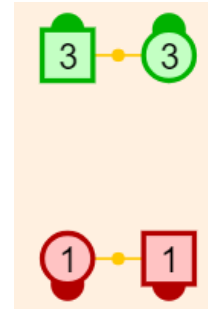

Slide Thru:

Begin with Facing Couples. The call is identical to **Star Thru**, but without hands. **Pass Thru** with the boy turning to his right while the girl turns to her left.

Start:

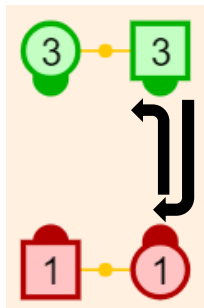

Finish:

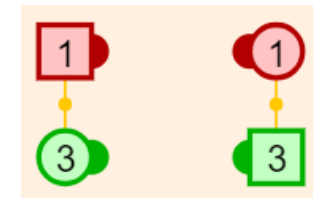

Dive Thru:

Begin with Facing Couples. The couples with their back to the center makes an arch with their inside hands and walks forward. The outside couples dive under the arch. The arch couple finishes with a California Twirl to face into the square again.

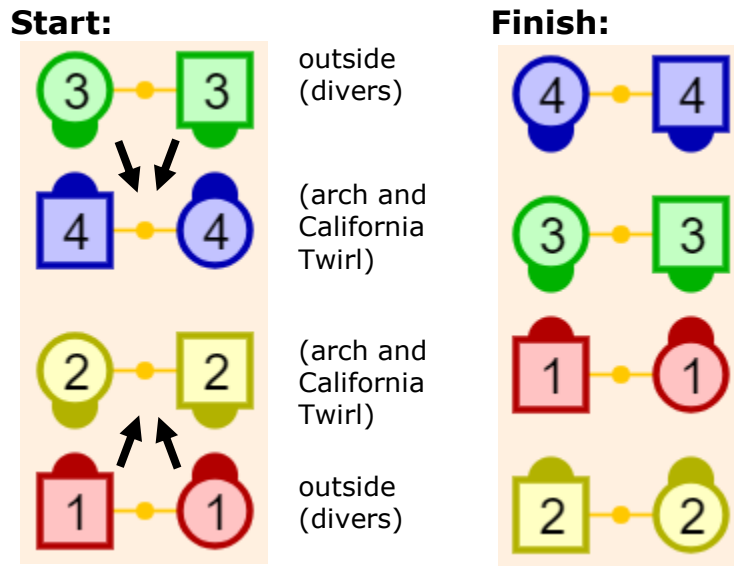

Right and Left Thru:

Take the right hand of the person in front of you and pull by, passing right shoulders. Step straight ahead and do a **Courtesy Turn** with your partner, to face the couple you just passed thru.

Make Lines:

Not actually a call, although it's as important as any call you could learn! When you're dancing, squares crash. You should:

- 1) Return to Home.
- 2) Make Lines: Sides slide to their right and heads slide over beside them. When the caller says, "You've got lines," you're back in the game!

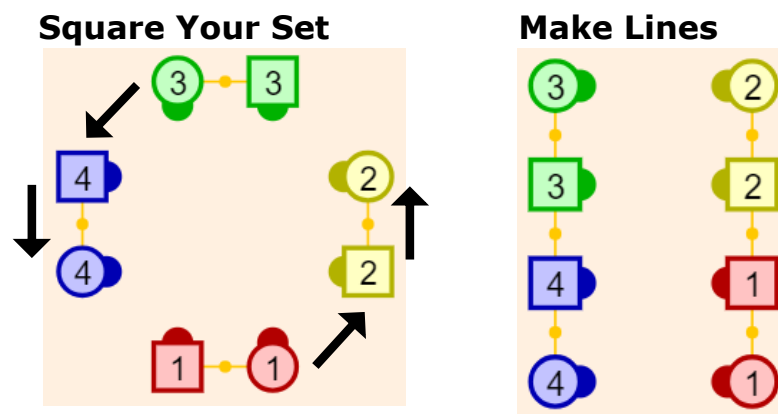

CLASS 4

CALLS

Trade:

You switch places with someone. It is always achieved by walking forward in a semicircle into the position of the person with whom you're trading. You will face the opposite direction from where you started. It may be done with hands held or without (in which case, just pass right shoulders). The trade may be designated for Centers, Ends, Boys, Girls, Couples, or Partners.

From Opposite Direction

Start:

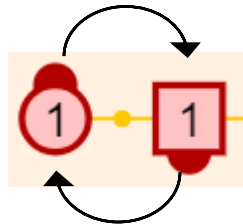

Finish:

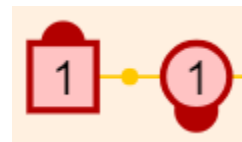

From Same Direction

Start:

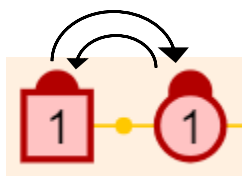

Finish:

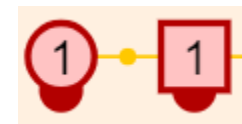

Partner Trade:

Begins as a couple facing the same direction (see above). Drop hands, walk a half circle forward into your partner's position, passing right shoulders. The boy walks a slightly larger loop and the girl takes the shorter route. You end up facing the opposite direction from where you started, still side by side.

Lead Right / Left:

Designated couple moves forward along a 90° arc to face the couple (or wall) to their right (or left).

Start:

(Heads Lead Right)

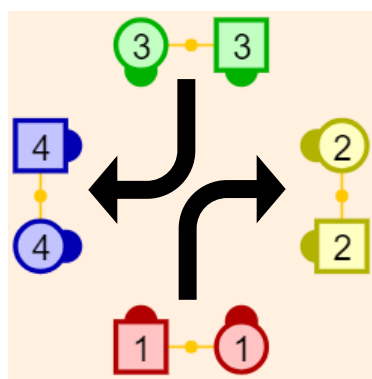

Finish:

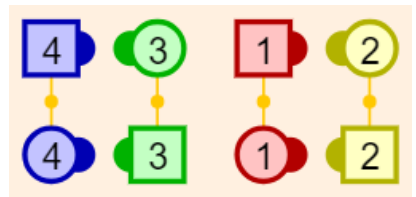

Veer Right / Left:

Designated couple moves either right or left and forward. There is no change of direction. If you begin as facing couples, you end in a two faced line.

Start:

(Veer Left)

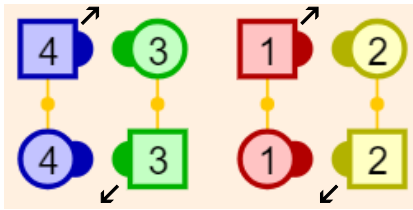

Finish:

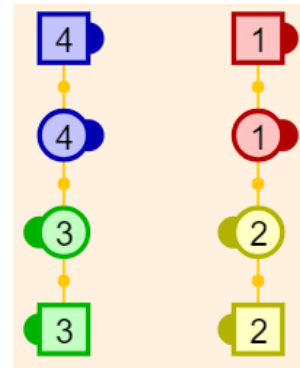

Circulate:

To circulate simply means to move to the next position along a path. You will see circulates time and again as you move through square dancing. The only hard part is seeing the path, because the path changes depending upon the formation and the call.

Couples:

From Two Faced Lines, you are moving forward around an oval. If you're a trailer facing someone's back, simply walk directly forward. If you're a leader facing out, your next position is beside you. Walk forward a 1/2 circle or 180°. If you start as an End, you'll stay an End. Centers stay Centers.

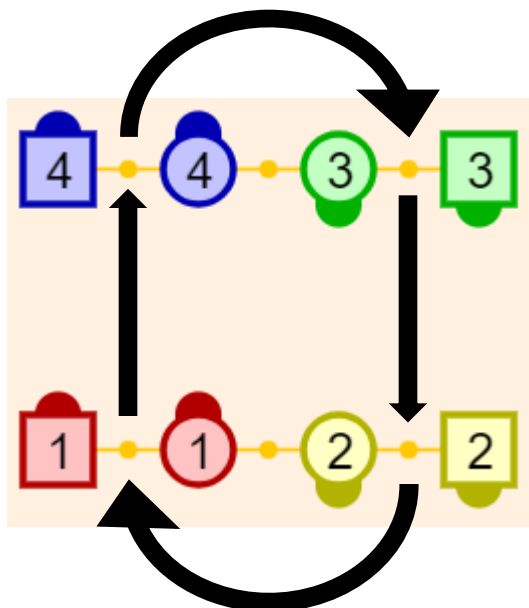

Circulate (continued)

Individuals: Movement is still forward along an oval path, but it is just the designated individuals—boys, girls, ends, or centers.

Boys/Ends Circulate

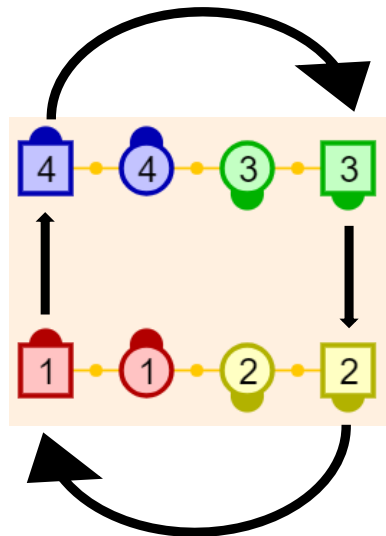

Centers/Girls Circulate

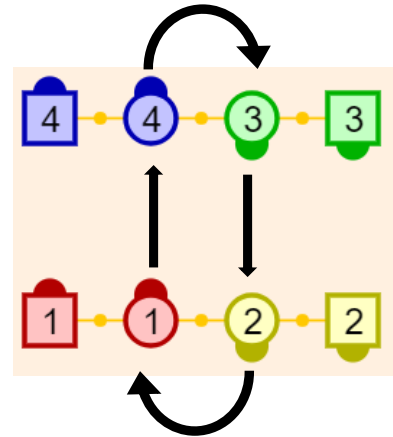

Centers Trade:

From a Two Faced Line, typically there will be two people of the same gender holding hands in the center. Those two people trade with each other by turning halfway with the common hand.

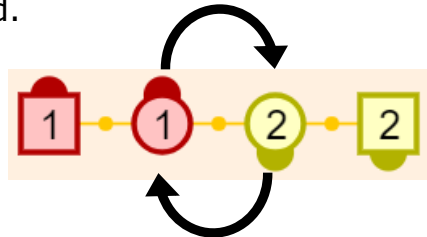

Ends Trade:

From a Two Faced Line, the ends simply walk to the other end of the line, trading places with each other.

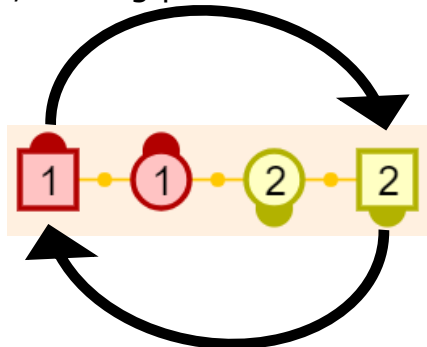

Chain Down the Line:

A Ladies Chain from a Two Faced Line. The girls in the center turn half by their right hand and offer the left to the boy for a Courtesy Turn.

CLASS 5**CALLS****Swing:**

When facing your partner, step forward and slightly left to connect in a ballroom hold (girl's left hand on boy's shoulder, boy's right hand in middle of girl's back between her shoulder blades, girl's right and boy's left hands connected). The couple will rotate clockwise using a double time step. The right feet create a pivot point while the left feet create motion.

Flutterwheel:

From Facing Couples, the right-hand dancers (typically girls) let go of their partners' hands and take outside hands (rights) with one another. They turn around each other until they get back to where they started. During all this, they pick up a new partner. The left-hand dancers (typically boys) do not wait to be dragged across to the other side, but lead the way. The left-hand dancers (boys) will be opposite where they began. Rotation is clockwise.

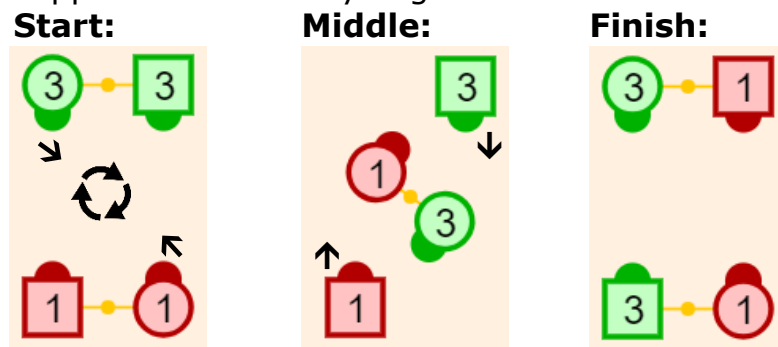
**Reverse Flutterwheel:**

From Facing Couples, the left-hand dancers (typically boys) let go of their partners' hands and take outside hands (lefts) with one another. They turn around each other until they get back to where they started. During all this, they pick up a new partner. The right-hand dancers (typically girls) do not wait to be dragged across to the other side, but lead the way. The right-hand dancers (girls) will be opposite where they began. Rotation is counterclockwise.

Sweep a Quarter:

Certain calls, like **Flutterwheel** and **Wheel & Deal**, involve rotation as they finish. You can ask people to keep the rotation going another 90° before they stop by adding **Sweep a Quarter** to the call.

CLASS 6

CALLS

Wheel and Deal:

From Two Faced Lines:

Each couple steps slightly ahead. Each couple then walks forward together in a 1/2 circle or 180° toward the center of the line. The dancer closer to the center acts as a pivot point for the couple. You will end facing the other couple.

Start:

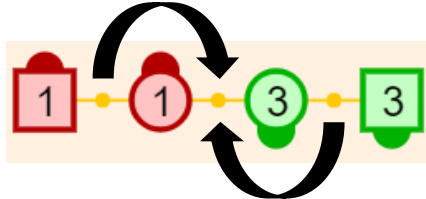

Finish:



From One Faced Lines:

Some adjustment is needed or you'll crash into each other! The couple on the right wheels in front of the couple on the left. To make this work the couple on the left needs to take an extra step forward before they wheel in to create a little space for the right-hand couple to get in front. Remember: right keeps it tight, left goes loose and larger. You will end in tandem couples.

Start:

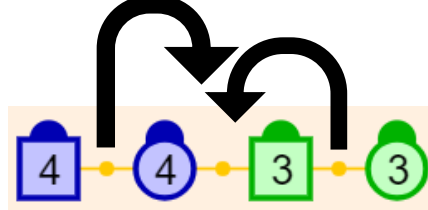

Finish:

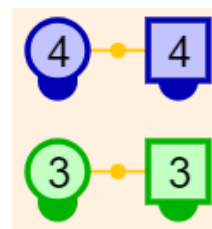

Double Pass Thru:

From Tandem Couples facing the center of the square (see below), everyone passes two people. Everyone is now facing out away from the center. The people in front are called Leaders and the people behind them are called Trailers.

Start:

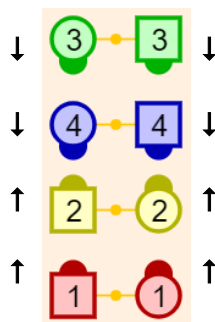

Finish:

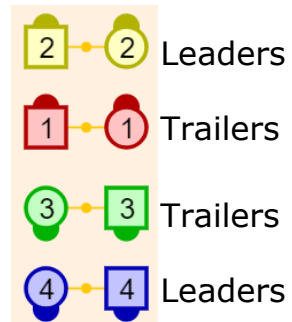

First Couple, Next Couple

Left / Right:

Following a Double Pass Thru, everyone is in tandem couples facing out. Each couple walks forward in a 1/2 circle, or 180° as indicated. The tandem couples will become a line.

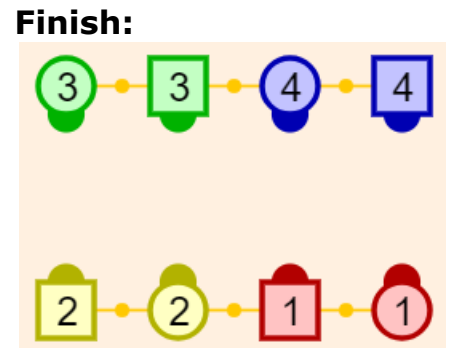
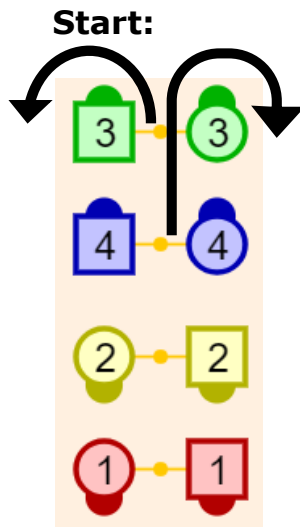

Circle to a Line:

Begins with Facing Couples. You have an outside couple facing in (1 in the diagram) and an inside couple facing out (2 in the diagram). All join hands and circle left half way. The left-hand dancer (boy 2) who began the call on the inside facing out drops the hand of the woman ahead of him (girl 1) and walks straight to form a line. The woman whose hand was dropped will be the other end of the line. She walks forward under the arm raised by her partner and then pivots into place.

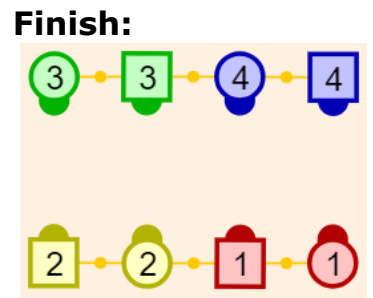
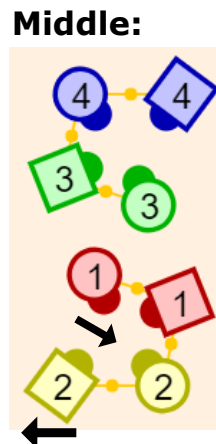
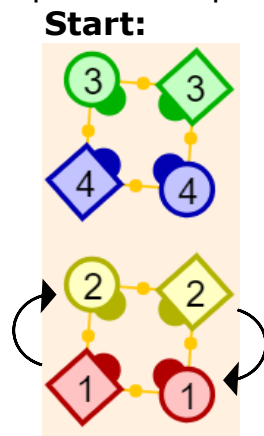

FORMATIONS

Double Pass Thru:

Tandem couples facing the center of the square.

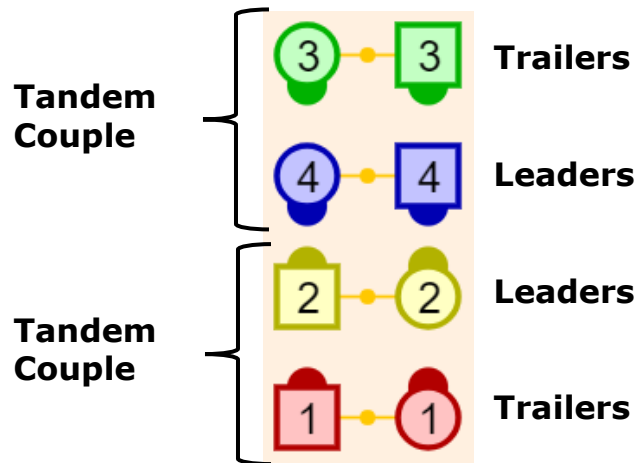

Tandem involves a dancer immediately behind another, facing the same direction. The person in front is the **leader**. The person behind is the **trailer**.

Completed Double Pass Thru:

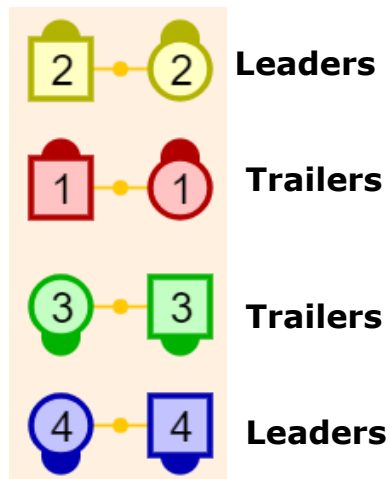

CLASS 7**FORMATION**
Ocean Wave

Dancers are in a wavy line facing alternating directions.

**Ocean Wave Rule**

The formation is considered similar to Facing Couples. Calls typical to that formation, may be called from a wave such as **Pass Thru, Slide Thru, Right and Left Thru**, etc. Just drop the hand and finish the call.

CALLS**Alamo Style:**

Starts with an **Allemande Left**, but as you finish the turn, hang onto the left forearm of your Corner as you reach for the right forearm of your Partner. You'll end up with the Corner in your left hand and your Partner in your right. It is a ring of people in a wave with alternating people facing in and out of the ring. From here, a **Swing Thru** could be done with everyone able to turn by BOTH the right and the left.

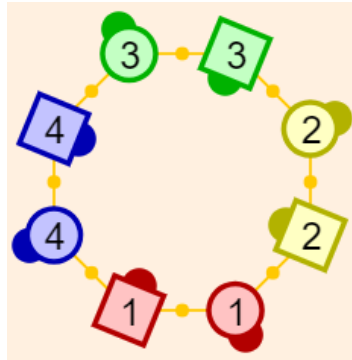
**Trade Right / Left:**

Turn half by the designated hand. You will walk forward in a $\frac{1}{2}$ circle or 180° to exchange places with the other individual.

Swing Thru:

Turn half by the right if you can, then half by the left if you can.

Left Swing Thru:

Turn half by the left if you can, then half by the right if you can.

Step to a Wave:

From Facing Couples, you step forward toward the person opposite you and take right hands. The two center dancers also take left hands together.

Dosado to a Wave:

Do a complete **Dosado** and then **Step to a Wave**.

Run:

Run means you walk forward in a ½ circle or 180° to take the adjacent dancer's position. When finished, you'll be facing in the opposite direction. The person whose place is being commandeered gets out of the way by sliding into the vacated spot left empty by the person doing the Run. Sliding people do NOT change direction.

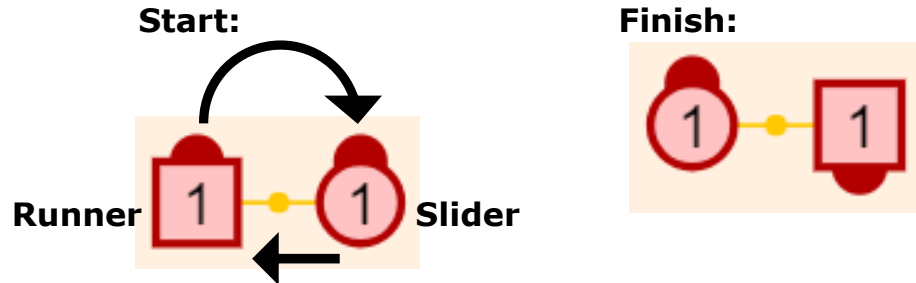

CLASS 8

CALLS

Ferris Wheel:

From a Two Faced Line, it is very much like **Wheel and Deal**. The couples facing out walk forward together in a 1/2 circle to face in. The couples facing in, step forward to make a line. They walk forward together in a 1/2 circle and end up facing one another. The square ends up in a Double Pass Thru Formation (tandem couples facing one another).

Start:

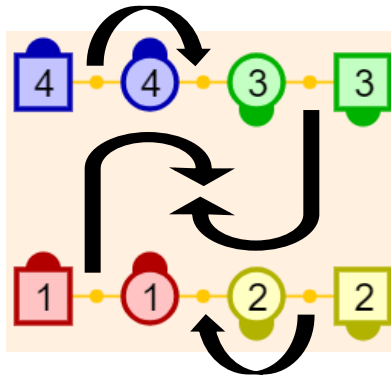

Finish:

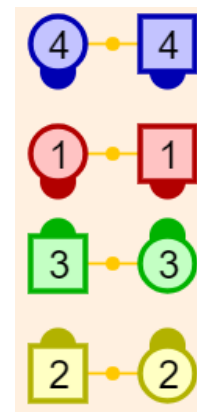

Pass the Ocean:

From Facing Couples, **Pass Thru** and turn to face your partner. Step forward to a right-hand Ocean Wave. Be aware of the midline of the square. Your wave will involve the individuals on your side of the square.

Start:

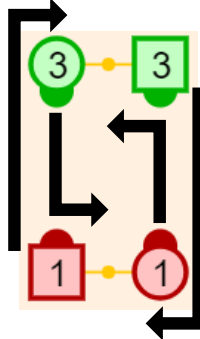

Finish:



Extend:

Step forward. If someone is in front of you and facing you, finish by stepping to a wave. Normally you'll want to step to a right-hand wave. If you begin in a left-hand wave, step forward to a left-hand wave.

**Circulate
(ocean wave):**

There is an inner or outer path you travel. If you are a trailer, just walk into the position of the person in front of you. If you are a leader, walk forward in a half circle, or 180°, to stay on the inner or outer path. Circulates may be designated people (boys, girls, ends, centers) but more commonly it is everyone (**All 8 Circulate**).

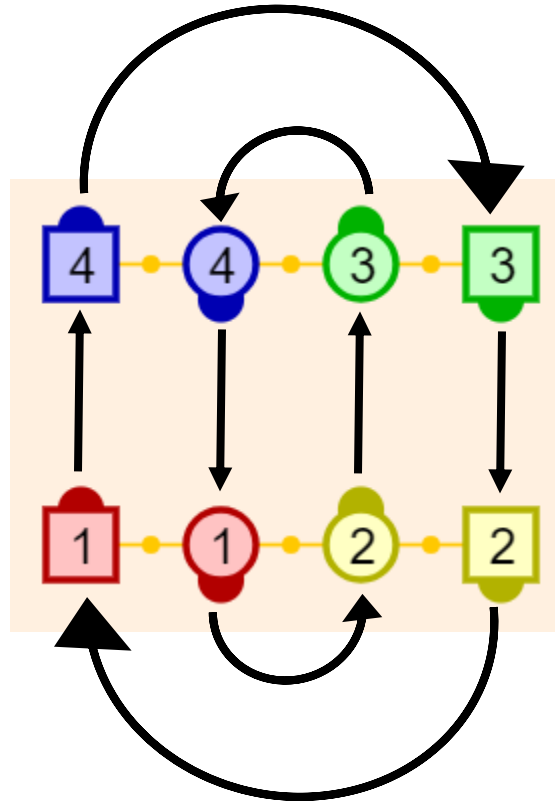

CLASS 9

CALLS

Zoom:

From Tandem Couples with Leaders in front and Trailers behind, the Leaders peel to the outside away from each other, walk an arc to end up in the Trailers' position. The Trailers step directly forward into the positions the Leaders have vacated. The two couples have switched positions.

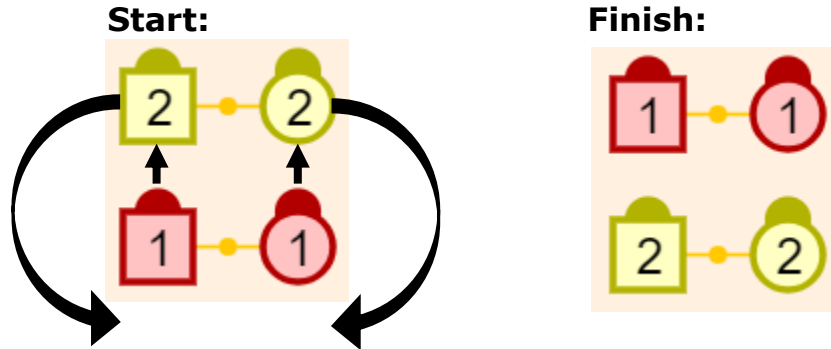

Trade By:

From the Trade By Formation (see next page), the couples in the center **Pass Thru**. The couples on the outside **Partner Trade**.

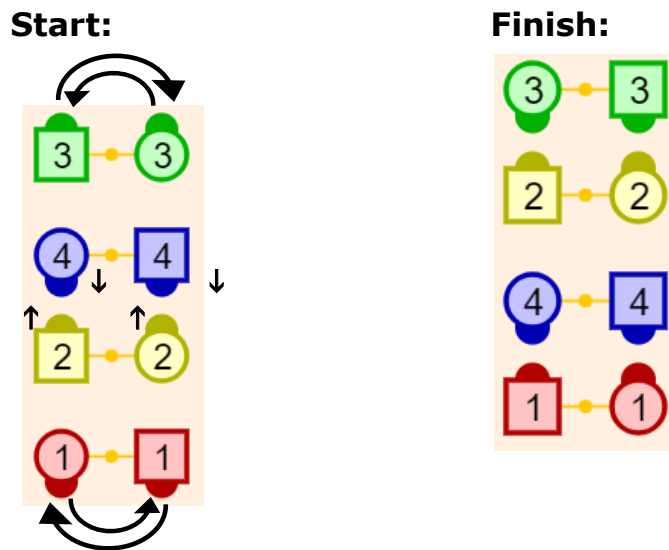

Girls / Boys Trade in a Wave:

When you are in an ocean wave, you may be called on to trade places with one another. As with all trades, you walk forward and into the other person's place, passing right shoulders. The non-designated people STAY in place. The result is a line with everyone facing the same direction.



FORMATION
Trade By

Couples in the center are facing one another.
Other couples are facing out.

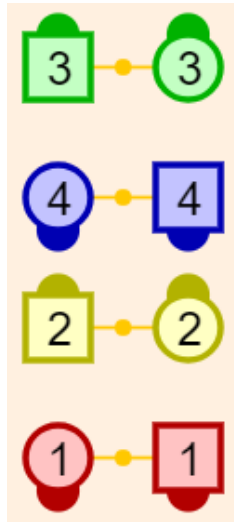

CLASS 10

CALLS

Box the Gnat:

Take right hands with the person you're facing. You're going to trade places, passing right shoulders. The joined hands are lifted and the girl goes under the raised hands as she turns toward her left. You end facing each other, still holding right hands and facing the opposite wall from the start of the call.

Cross Run:

When you **Cross Run**, you cross the center line. Instead of running into the spot next to you, you run into the spot on the other side of the wave or line. The designated people (Centers, Ends, Boys, Girls) run while the others slide to make room for them. Ends become Centers and Centers become Ends, but on the other side of the line. It may be called from two faced lines or ocean waves.

Two Faced Line

Start:
(Boys Cross Run)

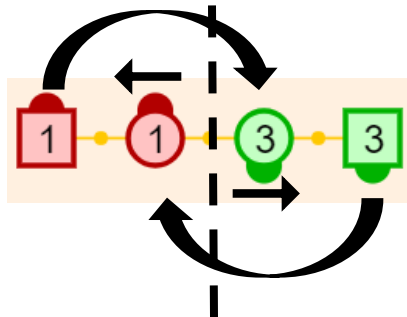

Finish:

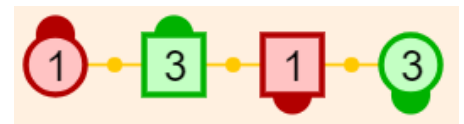

Ocean Wave

Start:
(Girls Cross Run)

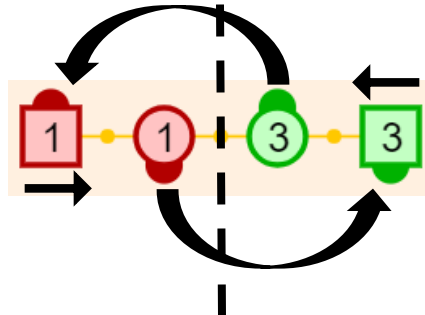

Finish:

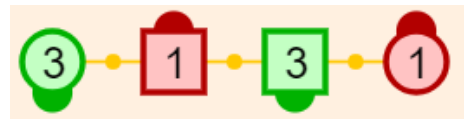

Hinge:

Half of a **Trade**. You walk 90° or a ¼ circle forward.

Single:

Each individual walks 90° or a ¼ circle forward. It is most commonly done in an Ocean Wave and you may be able to establish a new wave that is perpendicular to your old wave.

Start:

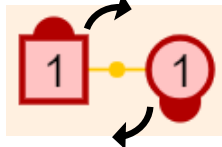

Finish:

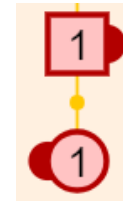

Couples:

Half of a **Couples Trade**. The couple walks 90° or a ¼ circle forward together. It is most commonly done from a Two Faced Line. You will end in a Two Faced Line perpendicular to the original.

Start:

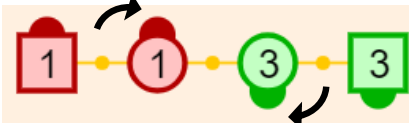

Finish:

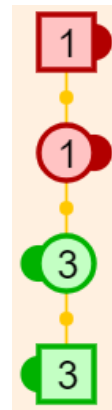

Partner:

Half of a **Partner Trade**. Begins as a side by side couple facing in the same direction. You begin a **Partner Trade** and stop at the halfway mark when you are right shoulder to right shoulder. Each individual walks 90° or a ¼ circle toward their partner. Take right hands. You end up perpendicular to your original facing direction, holding right hands and the two of you are facing in opposite directions.

Start:

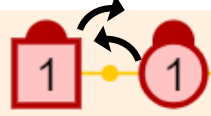

Finish:



Touch a Quarter:

This is the same as a **Hinge**, but it begins when you're facing someone. Step forward and take right hands, then **Hinge**. It may be done with left hands (**Left Touch a Quarter**).

Start:

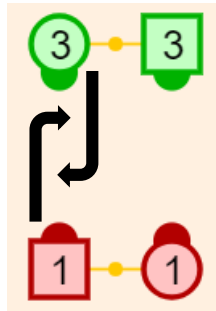

Finish:



Column Circulate:

From Column position (see below), drop hands and walk directly forward to the next position. If you are the Leader of the column, you need to walk forward in a 1/2 circle to join the other column. It may also be called **Single File Circulate**.

Start:

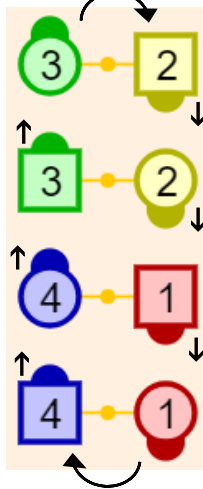

Finish:

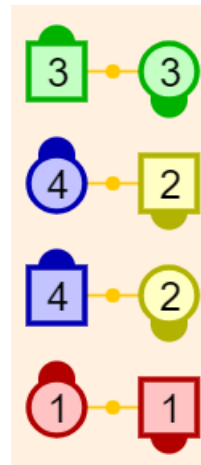

**FORMATION
Columns:**

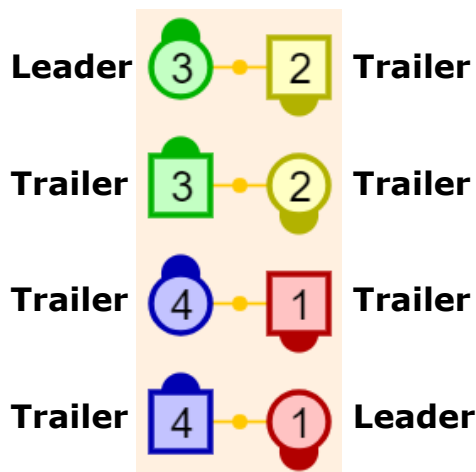

CLASS 11

CALLS

Split Circulate:

The square is "split" in half with a center line that should not be crossed. Circulate just within the group of four on your half of the square.

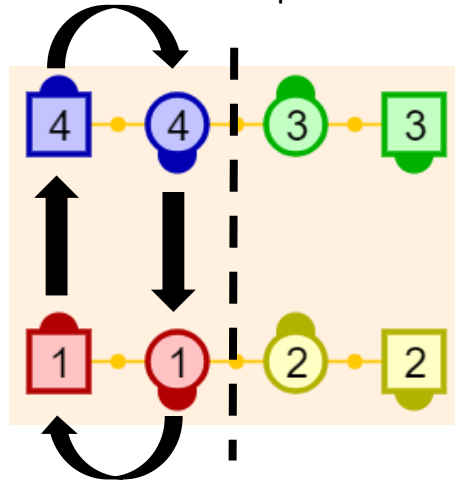

Box Circulate:

Only the Centers circulate. It is the same action as on an **All 8 Circulate**, but without any action from the Ends.

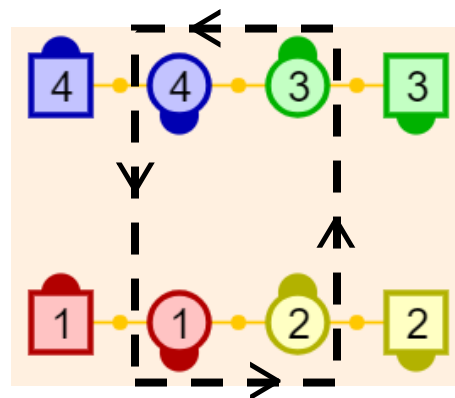

Centers In:

From a completed **Double Pass Thru**, the Leaders slide apart and the Trailers step forward in between them to form a one faced line.

Start:

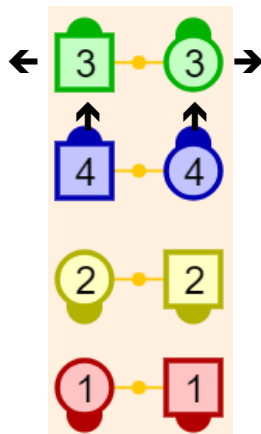

Finish:

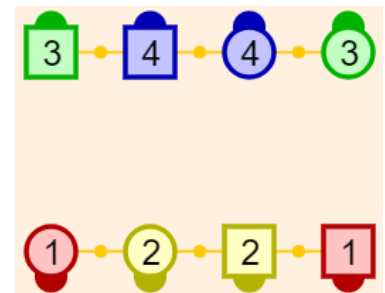

Cast Off $\frac{3}{4}$:

End and adjacent dancer rotate $\frac{3}{4}$. If you are facing opposite directions, it's easy. You both walk forward $\frac{3}{4}$ of a circle (270°). If you're facing the same direction, the Center walks forward and the End backs up.

Opposite Directions (Wave):

Start:



Finish:



Same Direction (One Faced Line):

Start:

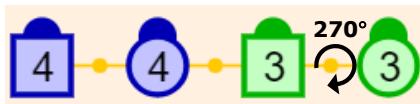

Finish:

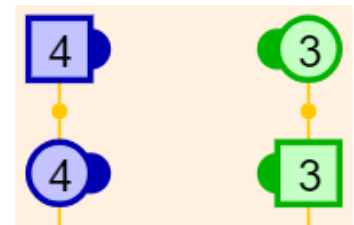

Left Hand Calls:

There are many calls that can be done with the left hand. The caller will usually give you a heads up on those by calling **LEFT Square Thru**, **LEFT Swing Thru**, **LEFT Trade**, or **LEFT Touch a Quarter**. Be sure to be listening carefully for these variations on calls you already know!

CLASS 12

CALLS

Fold:

The designated people (Boys, Girls, Centers, Ends) walk forward in a 1/2 circle or 180° to stand in front of or behind the person next to you. You will end up either nose to nose or facing their back. The person not folding does not move at all. Folding dancer will face the opposite direction from where they began.

Lines Facing Out

**Start:
(Boys Fold)**

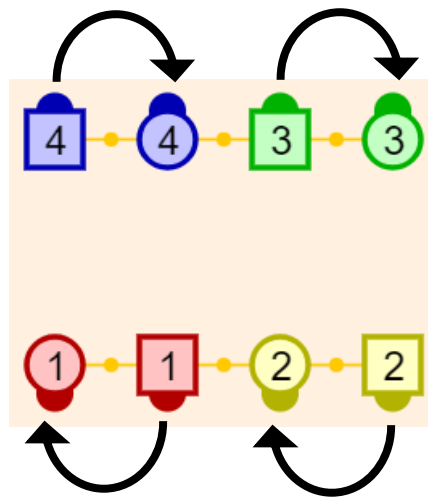

Finish:

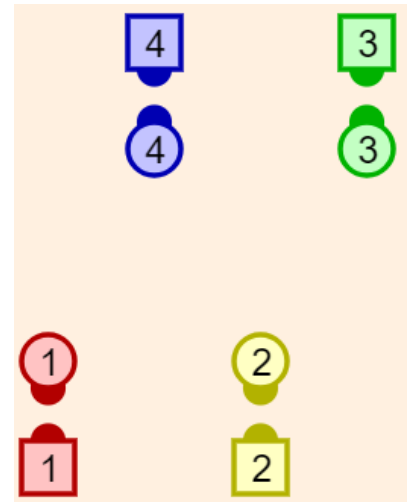

Ocean Wave

**Start:
(Girls Fold)**

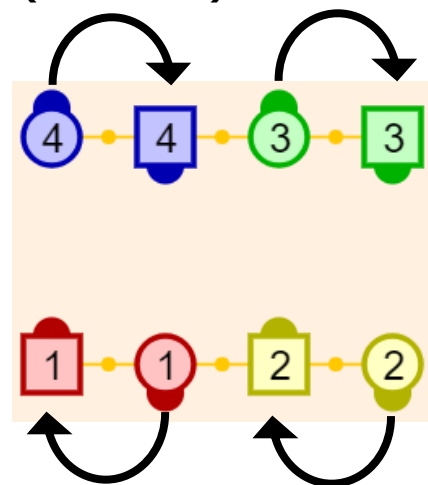

Finish:

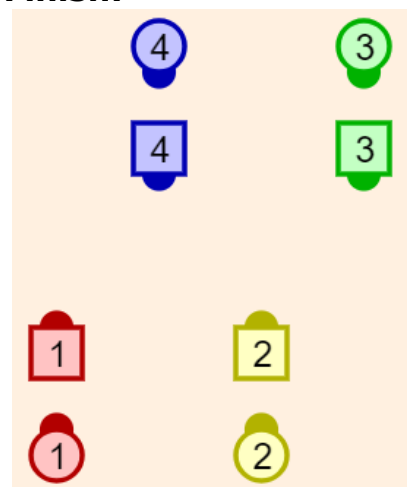

Cross Fold:

Similar to a **Fold**, but the "Cross" means you cross the center line and **Fold** in front of or behind the person on the other side of the line or wave. The designated people (Centers, Ends, Boys, Girls) move, but the other people remain stationary. Folding dancers will face the opposite direction from where they began. Remember to pass right shoulders with anyone coming toward you.

One Faced Line

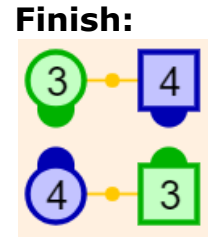
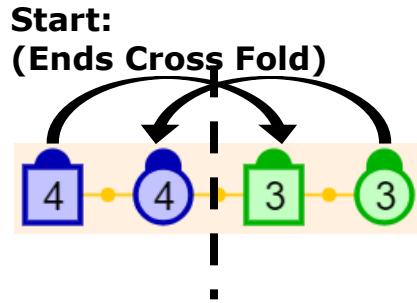

Two Faced Line

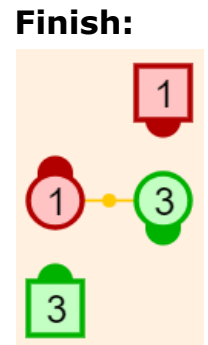
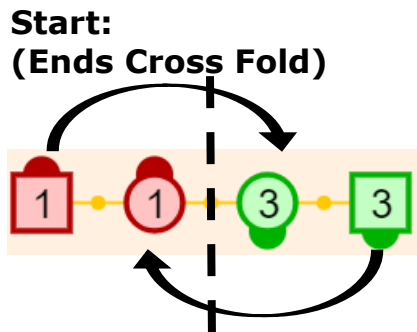

Ocean Wave

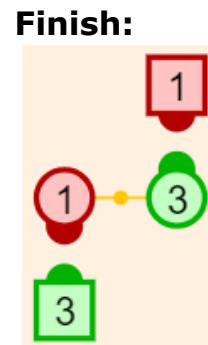
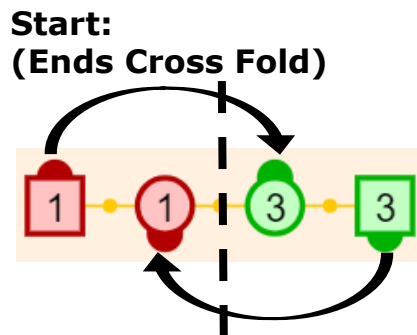

Tag the Line:

Turn to face the center of your line and walk forward passing right shoulders until you've completed a **Double Pass Thru**. From there, you may be told where to face next: In, Out, Left, or Right.

Start:

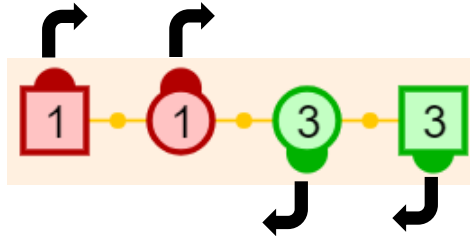

Middle:

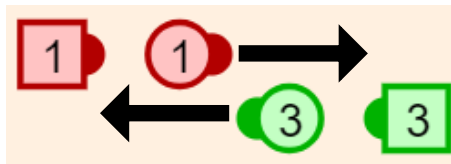

Finish:



Half Tag the Line:

There are four degrees of tagging the line possible: $\frac{1}{4}$, $\frac{1}{2}$, $\frac{3}{4}$, and all the way. If you **Half Tag the Line**, you turn to face the center of your line and the leader walks forward past only one person and then connects with the Trailer from the other half of the line form parallel Ocean Waves.

Start:

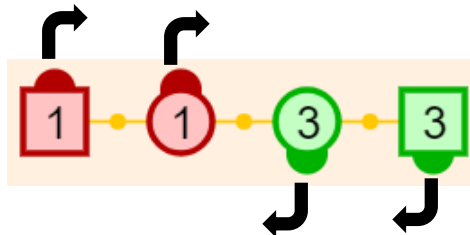

Middle:

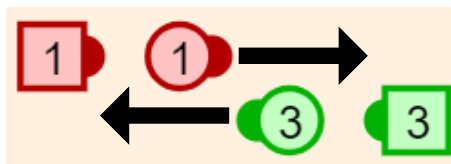

Finish:



CLASS 13

CALLS

Turn Thru

Done with a facing dancer. Step forward, take right forearms, and right arm turn 1/2. Release and take a step forward.

Start:

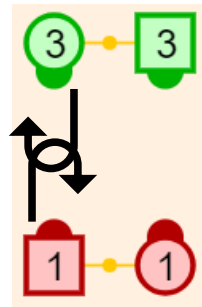

Finish:



Scoot Back:

Those facing out **Run** into the adjacent dancer's spot. Dancers facing in step straight forward to join inside forearms, turn half (180°), and step forward to end in the position vacated by the runner.

Start:

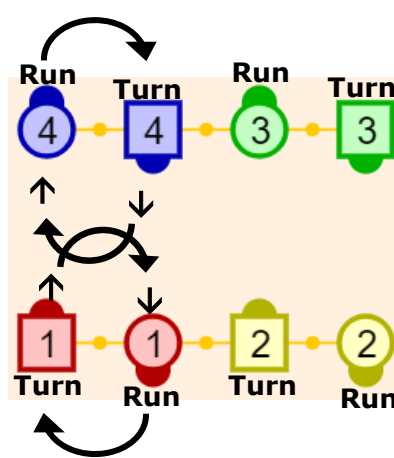

Finish:

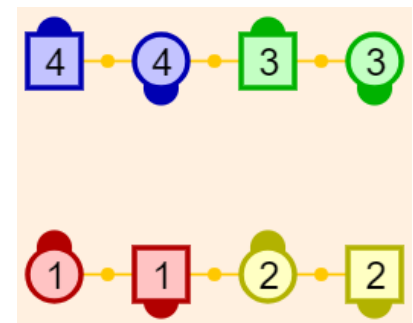

Recycle:

Wheel and Deal from an Ocean Wave. Everyone drops hands. Ends (usually boys), Cross Fold. Centers (usually girls) fold behind the Ends and follow them. You finish in facing couples.

Start:

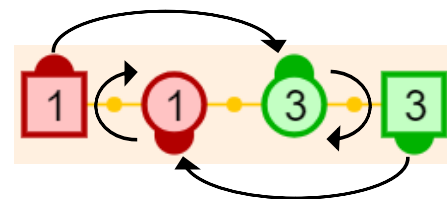

Finish:

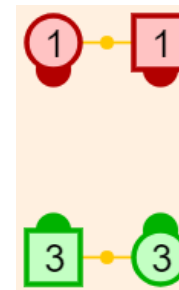

CLASS 14

CALLS

Star Promenade:

If the Men make a **Star** and turn it, the caller may then direct them to pick up the partner for a **Star Promenade**. As they pass their partner, they pick them up with an arm around her waist and promenade like that.

Backtrack:

Sometimes called as **Rollout to a Backtrack** and often done from a Star Promenade with the boys in the center and the girls on the outside. The people on the outside roll toward their outside shoulder and turn 180°. They walk around the outside and listen for the next command, often an arm turn of some sort with those on the inside.

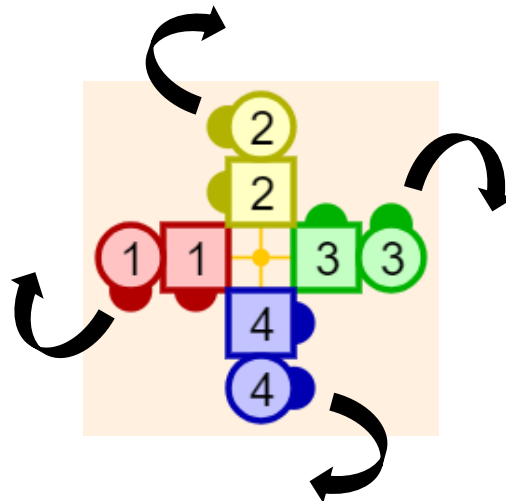

Separate and...:

Turn your back on your partner and go in opposite directions. There will usually be additional instructions to walk around the inactive individuals (see next page)

- ~ **Go Around 1 to a Line**
- ~ **Go Around 2 to a Line**
- ~ **Go Around 1 Come Into the Middle**
- ~ **Go Around 2 Come Into the Middle**

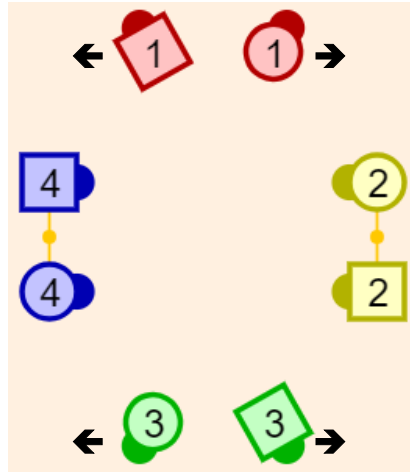

Split Two and...:

The inactive couple splits apart and you go between them. It may be followed by any of the additional instructions listed for **Separate and...** (above). The inactive couple slides together again after you have passed thru.

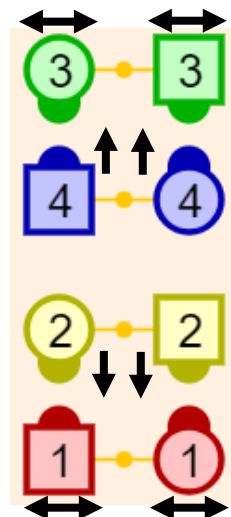

Separate and.../ Split Two and... Additional Instructions

~ **Go Around 1 to a Line:** You are going around 1 person and stepping in to form a line. The inactive couple will need to slide apart to let you in between them. The designated couple will be in center of the line, with the inactive individuals on the ends.

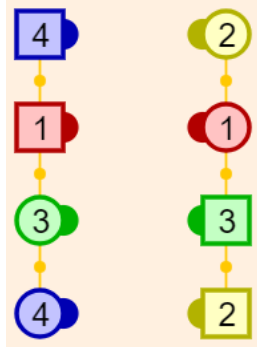

~ **Go Around 2 To a Line:** You are going around 2 people and making the ends of a line. You will pass right shoulders with your partner along the way. The inactive couple will remain in the center of the line and the designated couple forms the ends.

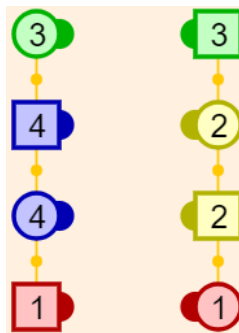

~ **Go Around 1, Come Into the Middle:** Go around 1 person and come into the center of the square. The inactive people will slide apart to let you enter and close behind you.

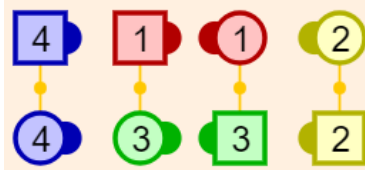

~ **Go Around 2, Come Into the Middle:** Go around 2 people and round the corner at the ends of the inactive couple. Join the other designated person approaching from the other side to go into the center of the square.

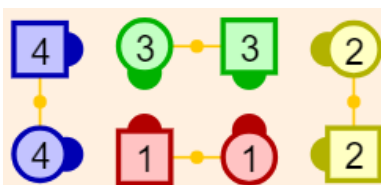

FORMATIONS
Static Square

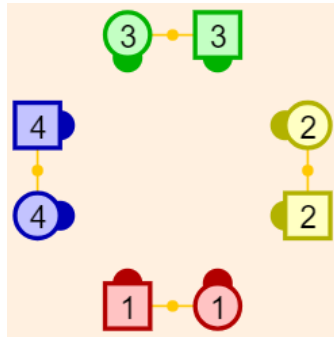

Facing Couples

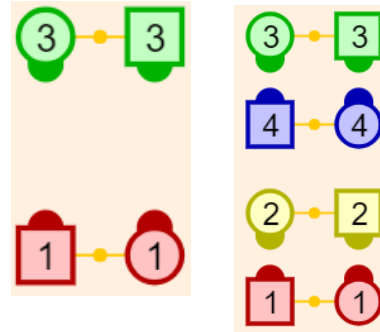

Half Sashayed Couples

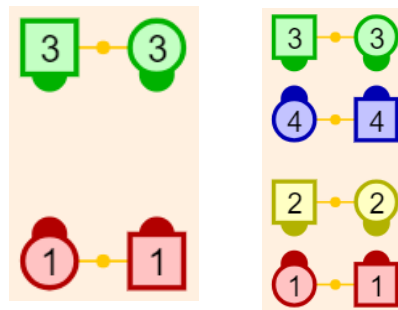

One Faced Lines Facing In

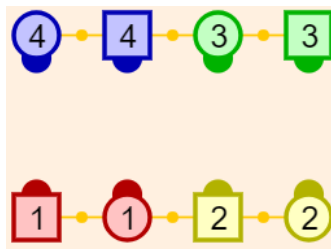

One Faced Lines Facing Out

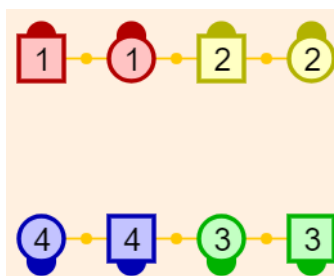

Two Faced Lines

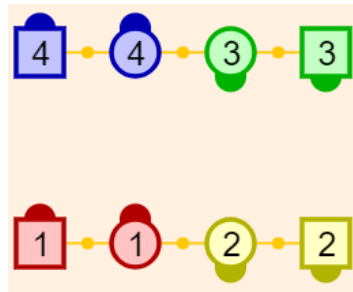

**Double Pass Thru
(Tandem Couples Facing Center)**

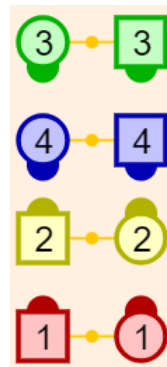

**Completed Double Pass Thru
(Tandem Couples Facing Out)**

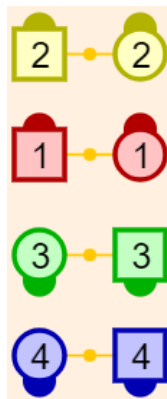

Ocean Wave

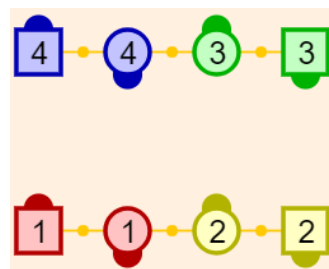

Alamo Wave

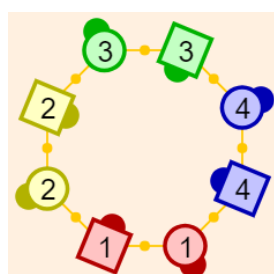

Trade By

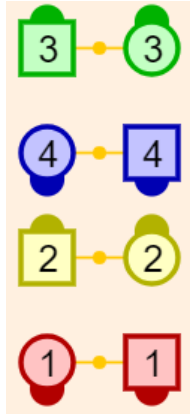

Columns

